



**BodorWelder Series**  
**Handheld laser welding machine**  
**User Manual**

**BodorWelder 1500 Pro**

**Original Instructions**

## Quotations

Thank you for choosing to use our company's products. We will provide you with perfect after-sales service and solutions, please keep this manual and other accessories, so that you can better use.

This specification gives a detailed introduction to the safe use of the products, including the installation, operation, and maintenance instructions, etc.

If you are using the product for the first time, please read this material carefully before using it.

Due to the constant update of the product functions, the product you receive may be different from the instructions. The Company reserves the right of final interpretation of this matter.

If you have any questions or better suggestions, please visit our website [www.bodor.com](http://www.bodor.com) to leave a message or call 24 hours for free 400-991-7771 for consultation.

## Directory

Quotations .....	II
Directory .....	III
Chapter 1 Description of Characteristics .....	1
Chapter 2 Security Information .....	1
1-The handheld laser welding machine is safe for use .....	1
2-Intended use and reasonably foreseeable misuse .....	2
3-Safety regulations .....	3
4-Laser protection .....	4
5-Safety of the welding features .....	5
6-Reference criteria .....	6
7-General safety instructions .....	7
8-The source of danger .....	12
9-More security information .....	12
Chapter 3 Product Description .....	13
1- Feature introduction .....	13
2-Refrigeration principle .....	14
3- Laser welding machine model description .....	14
4- Certificate of conformity .....	15
5- Rear panel description .....	16
6- Optical output terminal .....	16
7- Knob screen operation instructions .....	17
8- Joint specification .....	19
Chapter 4 Detailed Specifications .....	20
1- Optical characteristics parameter table .....	20
2- General characteristic parameter list .....	20
3- Installation environment requirements .....	21
4- Structure layout .....	23
Chapter 5 Unboxing Guide .....	24
1 – Unboxing steps .....	24
2 – Packing list .....	25
Chapter 6 User Guide .....	25
1-Precautions .....	26
2- Power connection .....	26
3-Securely lock the connection .....	26
4- Gas connection .....	26
5- Wire feeder connection .....	27
6- Startup procedure .....	31
7- Protective mirror replacement .....	32
8- Welding process parameter .....	34
Chapter 7 Maintenance .....	38
Chapter 8 Transportation and Storage .....	39
1- Transport requirement .....	39

2-Storage requirement..... 39

## **Chapter 1 Description of Characteristics**

The unique properties of the laser may cause safety hazards that cannot be considered simply as other light sources, and must be noted by all those operating or near the laser.

Therefore, Bodor Laser recommends: please strictly abide by all warnings and safety tips in this manual to ensure safe operation and optimal performance. In the process of operation, maintenance and service of the equipment, in order to ensure the safety of the operators and users, do not open the equipment.

## **Chapter 2 Security Information**

### **1-The handheld laser welding machine is safe for use**

Hand-held laser welding machine is a dangerous, invisible laser radiation laser products. This product emits infrared laser radiation at a wavelength of 1080nm, and the average power radiated by the welding head is greater than 100W, which will cause damage to the eyes and skin directly or indirectly exposed to such light intensity. The infrared radiation is invisible, and the laser beam can cause irreversible damage to the retina or the cornea. Always wear the appropriate and certified 1080nm near-infrared band laser protection glasses before running the handheld laser welding machine.

(1) For the safety of you and others, it is strictly prohibited to point the welding head to yourself or others;

(2) Handheld laser welding machine must wear appropriate and certified 1080nm near-infrared band laser protection glasses and high-temperature protection gloves before use;

(3) For the safety of you and others, the crocodile clip must be clamped on the welding workpiece before triggering the laser, and it is strictly prohibited to clamp it

in other places except the workpiece, so as to avoid potential safety risks caused by abnormal light;

(4) The welding operation of handheld laser welding machine shall be carried out in a separate space with laser protection; non-welding personnel and combustible and flammable materials should be more than 10 meters away from the welding table, and fire extinguishers should be placed near the welding area;

(5) A face mask should be worn when welding the high reverse material;

(6) Ensure that the handheld laser welding machine is grounded normally, otherwise it may cause the electrification of the product shell and personal injury to the operator; if the grounding is not operated as required, it may cause laser alarm, light, laser instability and other hidden faults;

(7) Do not work in the rainy and direct sunlight environment, otherwise it may cause high temperature and high humidity alarm or short circuit, affect the normal use of the laser, and even cause safety risks.

## **2-Intended use and reasonably foreseeable misuse**

### **1. Intended use**

This product uses a high-energy density laser beam as a heat source to achieve laser welding and cutting functions by locally heating and melting the base material. This product can achieve the same welding of metal materials such as steel, aluminum, copper, and stainless steel, as well as the mutual welding between carbon steel, stainless steel, and galvanized sheet.

### **2. Reasonably foreseeable misuse**

#### **(1) Low melting point materials**

Materials such as zinc, lead, tin, etc. have lower melting points and are prone to vaporization during laser welding, resulting in the inability to form good welding joints.

#### **(2) Oxide materials**



Materials such as silicon dioxide and aluminum oxide are prone to react with oxygen in the air to form an oxide layer, which affects the welding effect.



(3) Transparent materials

Materials such as glass and crystal have a high transmittance to laser, making it difficult to form a good melting pool on the surface of the material, and therefore are not suitable for laser welding.

### 3-Safety regulations

As shown in the following table, all safety warning signs during the operation of the handheld laser welding machine include:

safety signs	Description
	<p>warning: There is potential harm to human body; follow certain procedures, otherwise it may cause certain harm to you or others. Do not violate the requirements of the warning sign during the operation to ensure the personal safety of the operator.</p>
	<p>This logo represents the laser radiation, and we have attached this logo to the laser of the product outlet end.</p>
	<p>Warning: Potential hazards to products; It is necessary to follow certain procedures, otherwise your equipment or components may be damaged.</p>

 <p><b>DANGER</b> CLASS 4 LASER PRODUCT</p> <p><b>AVOID EYE OR SKIN EXPOSURE TO DIRECT OR SCATTERED LASER LIGHT</b></p>	<p>Class 4 laser product Avoid eye or skin exposure to direct or scattered radiation</p>
 <p><b>LASER</b> <b>2</b></p>	<p>Avoid eye or skin exposure to direct or scattered radiation</p>
<p>No logo</p>	<p>important: Do not ignore important information about product operations.</p>

**please note:**

© Bodor laser BodorWelder series handheld laser welding machine with a wavelength range of 1060 nm to 1100 nm, not within the visible range, but these beams may cause irreversible damage to the retina and cornea.

©Bodor Laser recommends that you wear qualified and safe protective glasses at all times.

### 4-Laser protection

1. Laser protection requirements

Laser safety protection glasses should be selected on the standard of shielding the laser within the entire wavelength range emitted by the laser.

When operating the laser equipment, select safety glasses according to the laser wavelength and ensure that the laser is worn at all times.

If the device is a laser tunable or Raman product, it will emit a laser beyond the normal output wavelength range of the device laser, which should be protected accordingly.

2. Laser protection equipment manufacturer



Bodor Laser recommends the following materials or equipment from several laser safety equipment suppliers: LaserVision USA、Ketek Corporation 、Rochwell Laser Industries Etc. 。

These supplier information provided by Bodor Laser accounts only for the convenience of user use and is not liable for any problems caused by the use of the above supplier's products.

## **5-Safety of the welding features**

### **1. Radiation hazards**

Visible and invisible light radiation are generated during welding. The interaction between a high power laser beam and the welded target material may produce a plasma that produces UV radiation and "blue light," which may lead to conjunctivitis, retinal photochemical damage, or skin sunburn-like reactions. Welders exposed to invisible UV light without adequate protection may suffer permanent eye damage.

### **2. Skin hazards**

Exposure to infrared light and ultraviolet radiation during welding damages the skin. Infrared and ultraviolet light can cause skin burns, increasing the risk of skin cancer and accelerating signs of skin aging. Welding sparks may also cause burns. Laser material processing can transfer a lot of energy to the parts. Even after the cutting process is done, the parts can be very hot. Ensure that appropriate PPE is used to prevent potential burns. Take precaution to prevent skin damage by wearing protective clothing such as fireproof gloves, hats, leather aprons and other fire-resistant clothing. The sleeves and collar should be buttoned up.

### **3. Fire hazards**

If combustible or flammable materials are near the welding area, the heat and sparks generated during the welding process can cause a fire or explosion. Laser welding can only be performed when there is no combustible material in the area. Do not weld containers containing flammable or combustible materials. If the contents of the container are unknown, they should be assumed to be flammable or combustible. Fire extinguishers should be located nearby, easily accessible and trained to use them.

#### 4. Smoke hazards

Welding "smoke" can be composed of very fine particles and gases. Welding smoke and gas come from the welding material

Or any combination of filling materials used, protective gases used, paints, coatings, chemical reactions, and air pollutants. Welding smoke can adversely affect the lungs, heart, kidneys, and the central nervous system.

(1) When welding, keep your head away from the smoke. Always weld in fully ventilated areas to ensure safe air breathing.

(2) Use the exhaust system to remove steam, particles and hazardous debris from the welding zone.

(3) Breathing apparatus may also be required in confined spaces and in other situations.

(4) Routine air monitoring shall be conducted to determine the hazardous smoke levels in the welding area.

#### 5. Cylinder safety

If the cylinder is damaged or placed near the welded area, the cylinder may explode. Protective gas cylinders shall be placed in places free from impact or damage. Place them away from heat sources, sparks, or flames. The cylinder must be stored upright and fixed to a fixed bracket. Need a working adjuster for the required gas and pressure. All hoses and fittings shall also be suitable for application and remain in good working condition.

### **6-Reference criteria**

laser safety:

IEC60825-1-2014

Functional Safety:

EN ISO 13849-1:2023 PL d

Safety of Machinery:

EN ISO 12100:2010

EN 60204-1:2018

EN ISO11553-1-2020

EN ISO 11553-2:2008

Electromagnetic compatibility anti-interference:

EN 61000-6-4:2007 + A1:2011

EN 61000-6-2:2005 + AC: 2005

EN 61000-3-2:2014

EN 61000-3-3:2013

**please note:**

© The Bodor Laser BodorPower series laser meets the Low voltage requirements specified in the “CE LVD Directive” of the European market.

© According to the relevant national standards and requirements, the laser must be classified according to the output power and the laser wavelength.

According to national standards, bodor laser high power BodorWelder series laser products belong to Class 4 products.

© According to the relevant EU standards and requirements, this product belongs to Class Class 4 instrument (according to EN 60825-1, clause 9).

## **7-General safety instructions**

### **1.Mirror Reflection**

The laser output port position may generate a secondary laser beam and radiate outward at multiple angles.

This phenomenon of the main beam in the laser is called mirror reflection.

Although the energy of the secondary laser beam is much less than that of the primary laser beam, this intensity may also cause damage to things such as the human eye, skin or the surface of some material.

**WARNING:**

© Because the laser radiation light is not visible, you must be extremely careful to avoid or reduce the mirror reflection.

## 2. Safety instructions for accessories

Laser optics can be damaged by laser exposure, such as video cameras, photomultiplier tubes and photoelectric secondary tubes.

Attention should be paid to the relevant device protection.

### **WARNING:**

© Bodor Laser BodorWelder series fiber laser output laser strength enough to cut or weld metal and burn

Skin, clothing and paint, ignition of volatile substances such as alcohol, gasoline, ether, etc.

Therefore, during operation, isolate flammable items around the laser.

## 3. Optical operation instructions

Bodor Laser strongly advises you to read the following operational points before operating the laser:

- (1) When the power supply is started, do not view the laser light hole directly;
- (2) Avoid the placement of the laser and related optical output devices on the same level as the eyes;
- (3) The laser output port shall be equipped with a mounted laser beam housing;
- (4) Ensure to remove the tail cover of the laser before the laser is opened, otherwise it will cause irreversible damage to the fiber output head of the laser;
- (5) According to the output power and wavelength of the laser requirements of safety protection equipment to ensure the safety of operators;
- (6) The door for the laser space shall have interlock control and warning signs to limit the safe area of the laser;
- (7) Do not use lasers in a dark environment;
- (8) Do not open the laser without installing optical coupling fiber or optical

output connector;

(9) Ensure that the laser is off or the power is off to install or remove the cut head or collimator;

(10) When debugging calibration and focusing, please carry it under the low power output condition, and then slowly increase to high power after commissioning;

(11) If the equipment is not operated in the manner guided in this document, the protection device and performance of the equipment may be weakened, and Bodor Laser will not no warranty.

(12) To avoid the laser working in the hazardous area with red condensation in the comprehensive environment shown in the following figure, the specific control standards are as follows::

Relative Humidity %	30	35	40	45	50	55	60	65	70	75	80	85	90	95
Ambient Temperature ( °C )	the dew point Td ( °C )													
10	-7.0	-5.0	-3.0	-1.3	0.0	1.5	2.5	3.6	4.8	5.8	6.7	7.6	8.4	9.2
11	-6.5	-4.0	-2.0	-0.5	1.0	2.5	3.5	4.8	5.8	6.7	7.7	8.6	9.4	10.2
12	-5.0	-3.0	-1.0	0.5	2.0	3.3	4.4	5.5	6.7	7.7	8.7	9.5	10.9	11.2
13	-4.5	-2.0	-0.2	1.4	2.8	4.1	5.3	6.6	7.7	8.7	9.6	10.5	11.4	12.2
14	-3.2	-1.0	0.7	2.2	3.5	5.1	6.4	7.5	8.6	9.6	10.6	11.5	12.4	13.2
15	-2.3	-0.3	1.5	3.1	4.6	6.0	7.3	8.4	9.6	10.6	11.6	12.5	13.4	14.2
16	-1.3	0.5	2.4	4.0	5.6	7.0	8.3	9.5	10.6	11.6	12.6	13.4	14.3	15.2
17	-0.5	1.5	3.2	5.0	6.5	8.0	9.2	10.2	11.5	12.5	13.5	14.5	15.3	16.2
18	0.2	2.4	4.0	5.8	7.4	9.0	10.2	11.3	12.5	13.5	14.5	15.4	16.4	17.2
19	1.0	3.2	5.0	7.2	8.4	9.8	11.0	12.2	13.4	14.5	15.4	16.5	17.3	18.2
20	2.0	4.0	6.0	7.8	9.4	10.7	12.0	13.2	14.4	15.4	16.5	17.4	18.3	19.2
21	2.8	5.0	7.0	8.6	10.2	11.0	12.9	14.2	15.3	16.4	17.4	18.4	19.3	20.2
22	3.5	5.8	7.8	9.5	11.0	12.5	13.8	15.2	16.3	17.3	18.4	19.4	20.3	21.2
23	4.4	6.8	8.7	10.4	12.0	13.5	14.8	16.2	17.3	18.4	19.4	20.4	21.3	22.2
24	5.3	7.7	9.7	11.4	13.0	14.5	15.8	17.0	18.2	19.3	20.4	21.4	22.3	23.1
25	6.2	8.6	10.2	12.3	14.0	15.4	16.8	18.0	19.1	20.3	21.3	22.3	23.2	23.8
26	7.0	9.4	11.4	13.2	14.8	16.3	17.7	19.0	20.1	21.2	22.3	23.3	24.2	25.1
27	8.0	10.3	12.2	14.0	15.8	17.3	18.7	19.9	21.1	22.2	23.2	24.3	25.2	26.1
28	8.8	11.2	13.2	15.0	16.7	18.0	19.6	20.9	22.0	23.0	24.2	25.2	26.2	27.1
29	9.7	12.0	14.0	15.9	17.6	19.2	20.5	21.3	23.0	24.1	25.2	26.2	27.2	28.1
30	10.5	12.9	14.9	16.8	18.5	20.0	21.4	22.8	23.9	25.1	26.2	27.2	28.2	29.1
31	11.4	13.8	15.9	17.8	19.4	20.9	22.4	23.0	24.8	26.0	26.9	28.2	29.2	30.1
32	12.2	14.7	16.8	18.9	20.3	21.9	23.3	24.6	25.8	27.0	28.1	29.2	30.1	31.1
33	13.0	15.6	17.6	19.6	21.3	22.9	24.2	25.6	26.8	28.0	29.0	30.1	31.1	32.1
34	13.9	16.5	18.6	20.5	22.2	23.8	25.2	26.5	27.7	29.0	29.5	31.1	32.1	33.1
35	14.9	17.4	19.5	21.4	23.0	24.6	26.2	27.5	28.7	29.9	31.0	32.1	33.1	34.1
36	15.7	18.1	20.3	22.2	24.0	25.0	27.0	28.4	29.0	30.9	32.0	33.1	34.1	35.2
37	16.6	19.2	21.2	23.2	24.9	26.5	27.9	29.5	30.7	31.8	33.0	34.1	35.2	36.2
38	17.5	19.9	22.0	25.0	25.8	27.4	28.9	30.3	31.5	32.0	33.9	35.1	36.0	37.0
39	18.1	20.8	23.0	24.9	26.6	28.3	29.8	31.2	32.5	33.8	34.9	36.2	36.8	38.1
40	19.2	21.6	23.8	25.8	27.6	29.2	30.7	32.1	33.5	34.7	35.8	36.8	38.1	39.1

**WARNING:**

© In order to ensure a good operating environment for the laser and reduce the probability of malfunctions caused by condensation. It is strongly recommended that the laser be used in a comprehensive environment with a temperature of  $\leq 30\text{ }^{\circ}\text{C}$  and a relative humidity of  $\leq 70\%$ .

pay attention to:

◎ The laser path output is exposed to a lens with an anti-reflective coating if your laser steps

The optical path has this kind of optical lens. Before using the laser, please strictly check the laser output head lens and the rear stage lens to ensure that there is no dust and any other debris on the lens.

Any visible attachment can cause severe damage to the lens, burning the laser or any rear optical path.

◎ Refer to the Optical Fiber Connector Inspection and Cleaning Guide to follow the cleaning inspection process for lenses.

◎ Be careful of the hot phenomenon or molten metal particles that may occur during the laser cutting operation.

◎ For laser output debugging and calibration, set the laser to pass through infrared under low power output conditions

Check the output spot quality of the laser, and then gradually increase the output power.

**WARNING:**

◎ Select safety protective equipment according to the output power and wavelength of the laser.

◎ Do not directly view the optical fiber or collimator, and ensure that safety glasses are always worn during each operation.

4. Electrical operation instructions

Bodor Laser strongly advises you to read the following operating points before operating the laser:

(1) Ensure that the equipment shell is well grounded and any point in the grounding circuit may lead to personal injury;

(2) For the power supply connected to the equipment, please confirm that the protection area is connected before use;

(3) In order to reduce the danger of fire, if necessary to replace the line fuse can

only be the same type, the same grade, and other fuses or materials cannot be used to replace;

(4) Ensure that the input AC voltage of the laser is normal AC city voltage (single phase voltage 220V), and the wiring is correct, any wrong wiring mode, may cause personal or equipment injury;

(5) This product has no parts, parts or components to be repaired by users, and all maintenance operations shall be completed by Bodor laser professionals;

(6) Do not remove the casing, remove the laser and destroy the relevant labels without authorization, there is a risk of electric shock or burn;

(7) Any unauthorized disassembly of the products will no longer enjoy the warranty rights.

**WARNING:**

© The input voltage of the laser is single-phase AC (220VAC), and there is a danger of electric shock.

All associated cables and cables have potential hazards.

5. Laser operating environment requirements

To ensure the safety of the laser work area, a suitable enclosure shall be used.

This includes but is not limited to the risk prevention work such as laser safety signs and interlock devices, and the interaction between the laser and the working surface, causing gas, sparks and debris due to high temperature, which may pose additional safety hazards.

The corresponding operators should undergo certain assessment training, and be familiar with and master the routine safety specifications of laser operation.

Note that the output component must not be installed at the same level as the eye.

Due to the interaction of the laser and the metal material, which produces intense ultraviolet or visible radiation, make sure the laser has a protective cover to avoid radiation damage to the eye or other parts of the body.

Bodor Laser recommends that you follow the following measures to extend the

service life of the laser:

(1) Please ensure that the working area is properly ventilated and that the laser is placed in the cabinet with temperature and humidity control and dust control function. Do not expose the laser to high temperature and humidity environment.

(2) Running the equipment at high temperatures will accelerate the aging, increase the current threshold, and reduce the laser sensitivity and conversion efficiency. If the equipment is overheated, please stop using it and ask the Bodor Laser for help.

**pay attention to:**

© Please operate the equipment carefully to avoid causing accidental damage to the equipment.

## **8-The source of danger**

Equipment hazard sources include laser and refrigerant.

## **9-More security information**

If you need more information on laser safety, please refer to: If you need more information on laser safety, please refer to:

Laser Institute of America(LIA)

13501 Erenuity Drive, Suite 128

Orlando,Florida 32826

Phone:407 380 1553,Fax: 407 380 5588

Toll Free:1 800 34 LASER

American National Standards Institute

ANSI Z136.1, American National Standard for the Safe Use of Lasers

(Available through LIA)

International Electro-technical Commission

IEC 60825-1, Edition 1.2



Center for Devices and Radiological Health

21 CFR 1040.10 - Performance Standards for Light-Emitter Products

US Department of Labor - OSHA

Publication 8-1.7 - Guidelines for Laser Safety and Hazard Assessment.

Laser Safety Equipment

Laurin Publisher

Laser safety equipment and Buyer's Guides

## **Chapter 3 Product Description**

### **1- Feature introduction**

The hand-held laser welding machine integrates the laser, the hand-held welding gun head and the control system together. Compared with the traditional hand-held welding equipment, it has the characteristics of simple configuration, high integration, small size, simple operation and high intelligence.

Main features:

- (1) High beam quality
- (2) High power, high efficiency
- (3) Compact, strong packaging
- (4) Can adapt to high and low temperature environment for a long time light

Application field:

- (1) Industrial applications
- (2) Scientific research
- (3) Medical equipment
- (4) Advertising industry
- (5) Kitchen and bathroom industry

## 2-Refrigeration principle

The compressor compresses the refrigerant, so that the refrigerant becomes a high temperature and high pressure gas, and flows to the external condenser. The high temperature and high pressure gas is condensed into a low temperature and high pressure liquid, and the heat generated by liquefaction is discharged out of the system with the fan. The liquid refrigerant of low temperature and high pressure becomes a state of low temperature and low pressure easy to evaporate after the pressure reduction through the expansion valve, and flows to the internal evaporator (that is, the cold plate). The evaporator absorbs heat, reduces the internal temperature of the laser, achieves the cooling effect, and then the refrigerant vaporizes into a high temperature and low pressure gas. After evaporating through the evaporator, the gas refrigerant is compressed again by the compressor, and the reciprocating cycle is implemented to achieve heat dissipation inside the system.

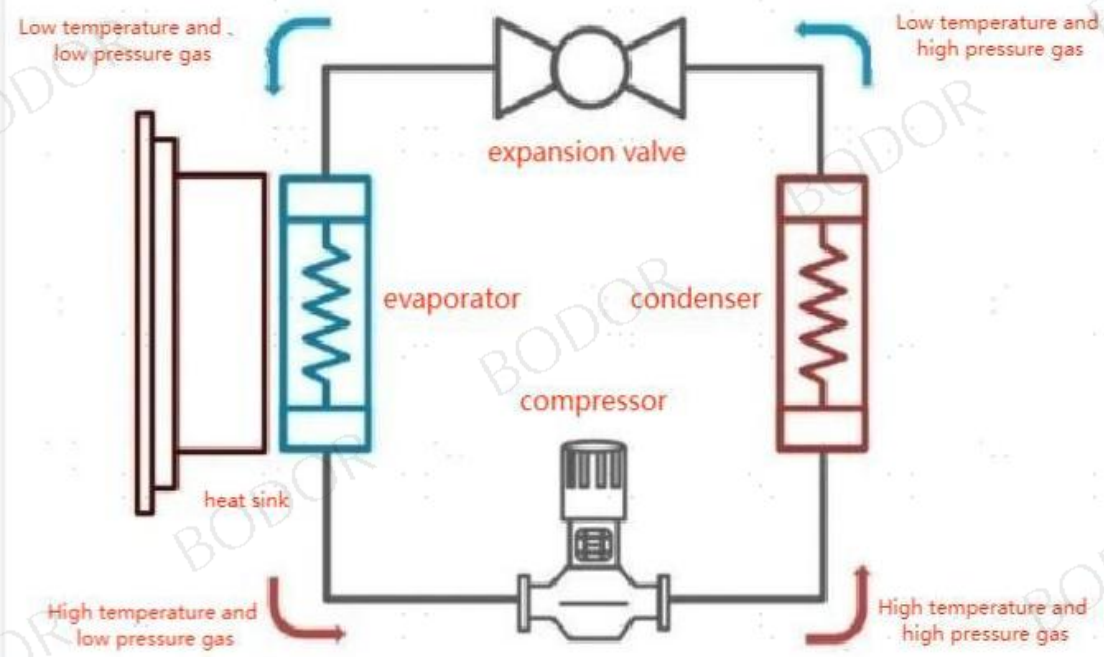

Figure 1 Refrigeration schematic diagram

## 3- Laser welding machine model description

Model nomenclature	Model meaning
BodorWelder 1500 Pro	Denotes Bodor Laser 1500W welding

	machine
--	---------

## 4- Certificate of conformity

Bodor Laser guarantees that the product has been thoroughly tested and inspected prior to shipment And meet the published specifications.

After receiving the product, please check whether the packaging and accessories are damaged due to the transportation process.If visible damage occurs, contact Bodor Laser immediately.

## 5- Rear panel description

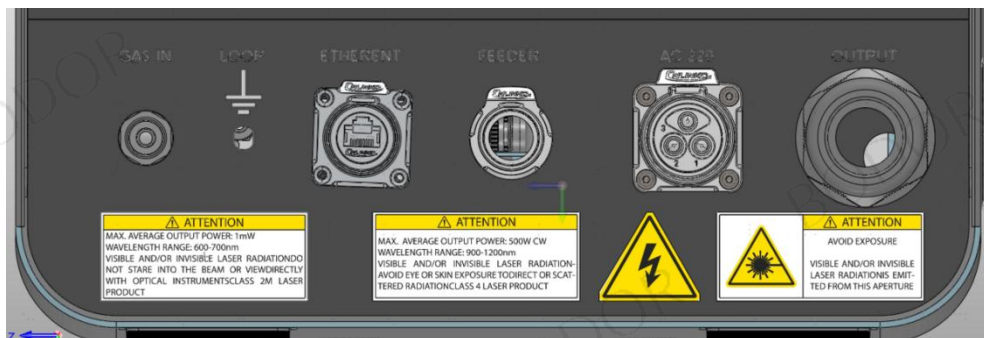

Name	Function description
OUTPUT	Nozzle joint
AC220	220 AC power input
FEEDER	Wire feeder interface
ETHERNET	Ethernet interface
LOOP	Ground protection
GAS IN	Protective air intake interface

## 6- Optical output terminal

The optical fiber head corresponds to the protection window and can be

replaced when damaged. Be sure to remove the QBH tail cap before use, which is usually placed with the laser.



Optical fiber Output head (QBH)



## 7- Knob screen operation instructions

Knob screen operation guide

- (1) Bodor is displayed after the device is powered on



- (2) The galvanometer is in adjustment
- (3) Hold down to enter the galvanometer parameter configuration screen, and set the center position of the galvanometer. Rotate clockwise to increase and counterclockwise to decrease (the center adjustment range of the galvanometer ranges from 0 to 65535). If the light spot is normal, press to skip this setting. Adjustable multiples can be set by pressing the knob short (x1,x10,x100,x1000,x10000).

After the setup is complete, you can pass the temporary storage  or save  verify the effect of parameters.



(4) Process package selection

The parameters are called and saved through the process package, the process package is selected by rotating left and right, and the detailed parameter table is entered after short press.



(5) Setting of process parameters

Press and hold in the detailed process parameter interface to enter the parameter setting interface, press the knob screen number to change color parameters, rotate clockwise to increase, rotate counterclockwise to decrease, press the knob screen number to white parameters to save, and rotate again to refer to other parameters.



After setting parameters, rotate to the save screen  and press to save.



(6) Device information query

On the knob screen, you can press to view device information.

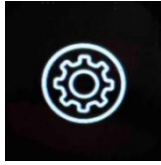

## 8- Joint specification



1. Brass mouthpiece
2. Graduated tube
3. Protective glasses
4. Focusing mirror
5. Galvanometer
6. Electric machine
7. Collimating mirror
8. QBH Protective case
9. Gas path
10. Switch button
11. Wire feed bracket

## Chapter 4 Detailed Specifications

### 1- Optical characteristics parameter table

Serial number	Characteristic parameter	Test condition	Minimum value	Typical value	Maximum value	unit
1	Working mode	Continuous/Pulse				
2	Polarization state	Random				
3	Output power	100% continuous	1450	1500	1550	W
4	Power regulation range		1%		100%	
5	Central wavelength	100% continuous	1070	1080	1090	nm
6	Spectral bandwidth			3	5	nm
7	Short-time power stability	100% continuous >1h		±1%	±2%	
8	Long-term power stability	100% continuous >24h		±2%	±3%	
12	Indicated red light power		0.1	0.5		mW
13	Optical fiber cable length			10		m
14	Output fiber core diameter			50		u m
15	Bending radius of the optical fiber		175			mm
16	Output mode	QBH				

### 2- General characteristic parameter list

Optical performance parameter	
Output power (W)	1500W
Working mode	Continuous/Pulse
Output power adjustment range (%)	1-100%



Output laser wavelength (nm)	1075±10
Power stability	< 3%
Laser response time	10us
Maximum modulation frequency	5k HZ
Indicated laser wavelength (nm)	650
Indicates the adjustable range of laser power (mW)	< 1mW
Laser conduction system parameters	
Interface type	Wire feed type hand-held welding head
Collimating focal length	50mm
Focal length	150mm
Transmission length	Standard length 10m±0.5m
Job requirement	
Cooling and protective gas	Inert gas
Operating ambient temperature range	-20~60°C
Working environment humidity range	≤90%
Input voltage	220 V
Overall power	4650 W

### 3- Installation environment requirements

- 1、 There should be no shelter within 1 meter of the inlet and outlet to avoid affecting the cooling effect of the equipment.



2、 Shall not be installed in corrosive, flammable gas, dust, oil mist, conductive dust (toner, metal powder), humid high temperature, direct sunlight and other harsh environment.

3、 The ambient air cleanliness level required for optical fiber output heads installation: Class 1000 or more. It is recommended to configure the corresponding standard purification workbench.

4、 Laser operating environment temperature:  $-20^{\circ}\text{C} - 60^{\circ}\text{C}$ .

5、 Laser operating environment humidity: 10% - 90%.

6、 Altitude:  $\leq 2000\text{m}$ .

7、 The lighting condition of the operating room is good, and there should be no interference from strong vibration and strong electromagnetic field equipment within 20 meters around the equipment(There is no interlocking or overlapping of wiring harnesses between devices).

8、 In order to ensure that the air in the equipment operation room is clean, the customer should set up the air extraction and smoke exhaust system according to the site conditions after the equipment installation and commissioning;

9、 Air pressure:  $\leq 8\text{bar}$

## 4- Structure layout

Three views of welding machine

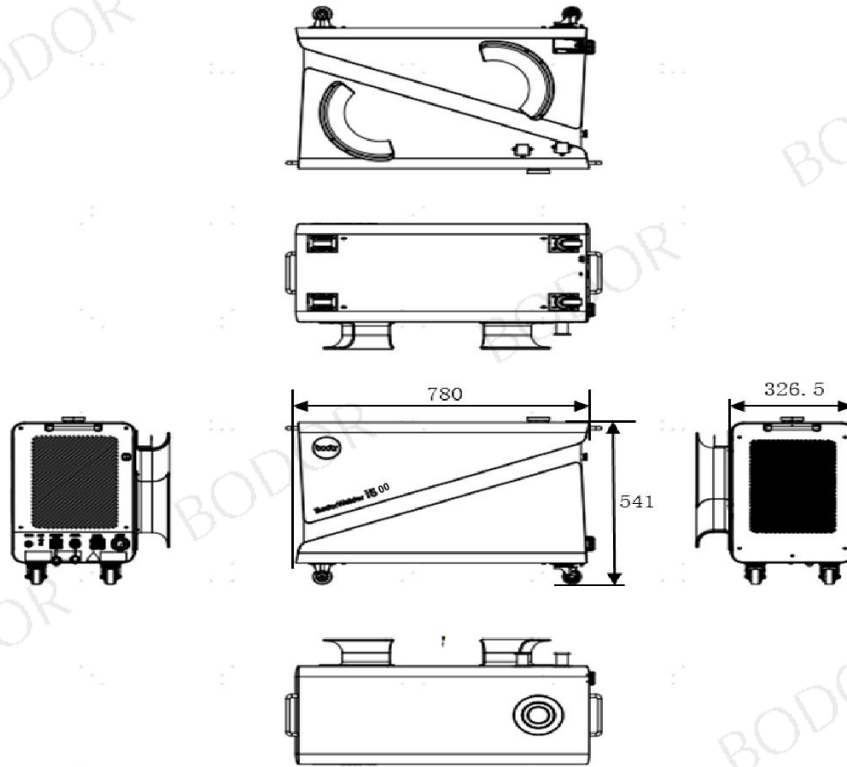

## Chapter 5 Unboxing Guide

### 1 – Unboxing steps

Welding machine is a precision valuables, Bodor laser recommend you to follow the following steps, step by step unpack the box:

(1) Place the packing case containing the laser device on a horizontal platform, such as the floor or a large table.

(2) Open the main packing box, remove the foam shielding plate, and take out the matching items.

(3) Take out the welding gun on the side of the welding machine to ensure the maximum bending radius of the optical fiber armor. 175mm, when taking out, it is recommended that two people work together to lift the welding machine out.

(4) Please check the parts against the Packing List.

(5) Please properly store all unpacked items in case of future transportation or storage needs.



#### **WARNING:**

© If you find any damage to the outer packaging or internal components after receiving the product, please contact Bodor Laser or local immediately Representative

contact.

## 2 – Packing list

Serial number	Name	Specification and model	Unit	Quantity
1	Fiber laser	BodorWelder 1500 Pro	PC	1
2	Wire feeder (individually packaged)	BF600 (Including power cord, wire tube, wire feed wheel)	PC	1
3	220VAC Power cord (onboard)	5 m	PC	1
4	Ground wire	10 m	PC	1
5	Copper muzzle box	Contains 8 copper nozzle, 1 graduated tube	PC	1
6	Protective lens	D18×2-PW-3KW-15	PC	5
7	Laser protective glasses	ADE-D4T35	PC	1
8	Cotton swab	BB-002-25 pieces	PC	4
9	Dust-free cloth	9 inches by 9 inches. -10 pieces	PC	1
10	High-soft Category 5 network cable Communication cables	SK-ECT 8-core 1M	PC	1
11	Trachea	PU6*4mm	M	0.1
12	Reducing	PG10-6	PC	1
13	QBH Black protective cap	/	PC	1
14	Welding machine usage guide	210*148.5mm	PC	1
15	Stock		PC	1

## Chapter 6 User Guide

## 1-Precautions

◎ Before the welding machine arrives for the first time and is energized, it needs to stand for 2~4H, because during transportation, the welding machine is likely to be affected by bumps and vibrations, resulting in the oil of the compressor being dispersed into other parts of the system, thus affecting the working efficiency and service life of the welding machine.

◎ During the use of the welding machine, it is forbidden to use it at an inclined angle.

◎ Please refer to the "Detailed Specification Sheet" section to select the appropriate power supply.

◎ Refer to the "General Safety Instructions section" to check whether the external working environment of the welding machine meets the requirements.

## 2- Power connection

The power input line of the welding machine needs to be connected to single-phase AC220V alternating current, please be sure to ensure that the fire wire, neutral wire and ground wire are well connected. Poor contact of the ground wire can cause potential damage to the laser. This power supply should be located close to the power supply unit of the equipment, so that the electrical power supply can be easily disconnected during operation.

## 3-Securely lock the connection

Before turning on the laser, the safety lock must be connected to the laser LOOP interface, and when the laser is ready to be released, the other end of the safety lock (crocodile clip) needs to be clamped to the workpiece, ensuring that the crocodile clip and the welding head form a loop before the laser can be released.

## 4- Gas connection

The welding head is cooled by inert gas to ensure welding purity and welding air pressure, generally using nitrogen and argon as shielding gas, the purity of shielding gas needs to meet 99.99%, and the inlet air pressure needs to be greater than 0.3 bar.

Connect the 6mm tubing to the GAS IN port to ensure a gas flow  $\geq 15\text{L/min}$ .

## 5- Wire feeder connection

### 1、 Operating environment and parameters

Supply voltage (V)	220 $\pm$ 10% V AC 50/60Hz
Placement environment	Flat, vibration and shock-free
Operating ambient temperature (°C)	10~40
Humidity of the working environment (%)	<70
The maximum supported wire weight	25KG
The maximum supported wire feeding wire diameter	2.0mm

Pay attention to the information

1.1 Make sure to be reliably grounded before power supply.

1.2 The wire feed wheel matches the wire diameter and corresponds to the wire feeding tube.

1.3 Do not bend the wire feeding tube.

### 2. Installation

#### 2.1 General definition of circuit wiring

2.1.1 The whole machine is provided with a three-core navigation plug, which is connected with the three-core navigation plug at the tail of the wire feeder and provides 220V power supply

2.1.2 The whole machine is provided with a two-core navigation plug, which is connected with the wire feeding port of the control system to provide wire feeding signals (passive contact, short wire feeding).

#### 2.2 Installation of Welding wire reel

2.2.1. The welding wire is an ordinary welding wire, and the common 5KG-25KG can be installed, but do not use the flux-cored wire;

2.2.2. Adjust the strength of the roller through the hex, so that it is not too tight



or too loose, and there is no delay when the wire is fed (usually no need to adjust);

### 2.2.3. Cover the cap once adjusted



## 3. Installation of wire feeding wheel

3.1 There are two wire feeding wheels in total, two sides are different models, corresponding to different core diameters, please be sure to install corresponding, such as the installation of 1.2 welding wire, the wire feeding wheel marked 1.2 side on the outside;

3.2 When installing, be sure to stick the welding wire in the card slot and then clamp it.

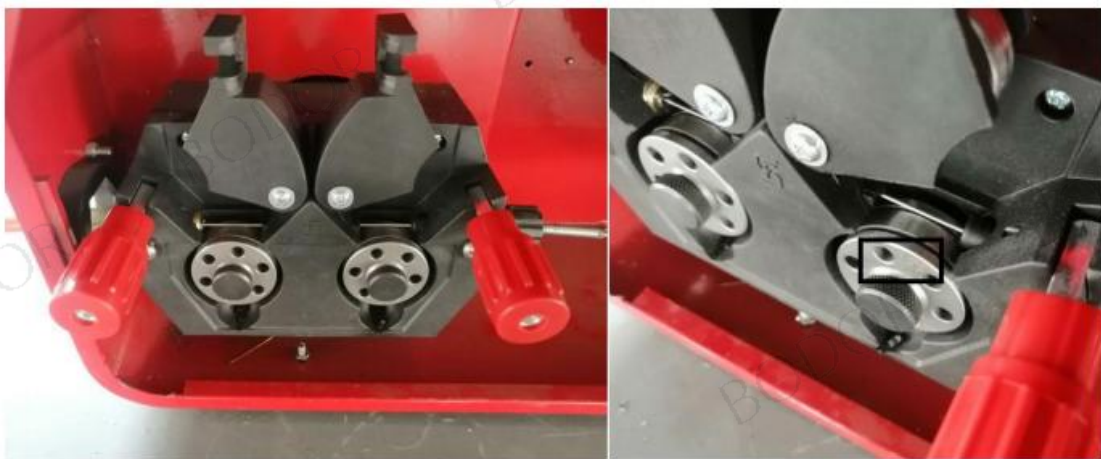

## 4. Installation of wire feeding tube



4.1. Put the wire into the wire feeding tube, insert it into the appropriate position, too short may cause the phenomenon of wire jamming, and then tighten the screw;

4.2. When installing the wire feed pipe, remove the copper tip of the end first and match the corresponding copper tip;

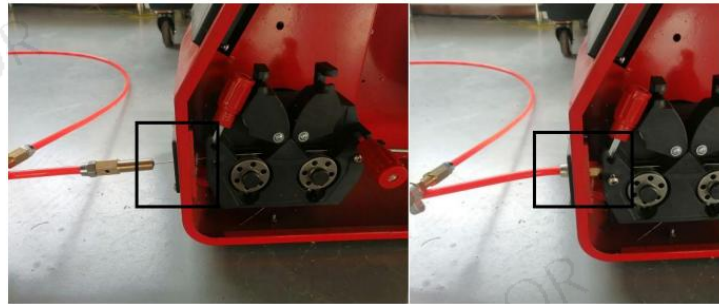

5. Operate the panel

5.1. The value of the home page shows the wire feed speed, which is adjusted by

the up and down keys. Please keep the running state when using;

5.2. Manual wire feeding: After holding down, the wire feeder starts to feed, and the manual wire feeding speed depends on the background setting;

5.3. Manual pumping: After holding down, the wire feeder begins to pump back, and the manual pumping speed depends on the background setting.

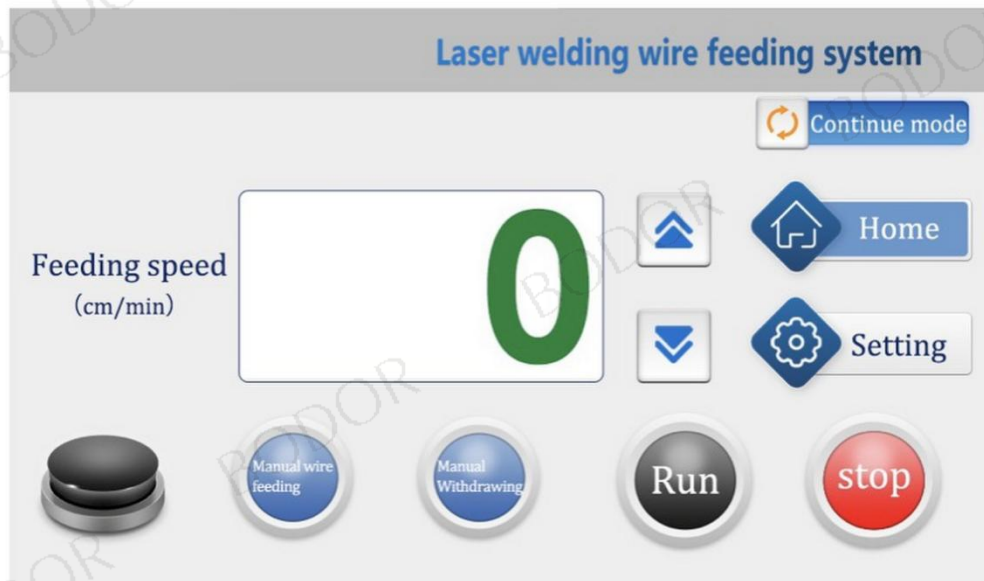

5.4. After all Settings are completed, click to save;

5.5. Set the wire feed speed of the page as the default wire feed speed, that is, after changing here, the switch still remains unchanged;

5.6. Startup delay: not set by default;

5.7. Withdrawal length and filling length: set according to actual use;

When the wire feed is stopped, the system will first pump back a certain distance and then a certain distance in the wire feed, this function is mainly used for breaking the wire;

When the wire is still outside at the beginning of each welding, please set the withdrawal length to be greater than the length of the wire.

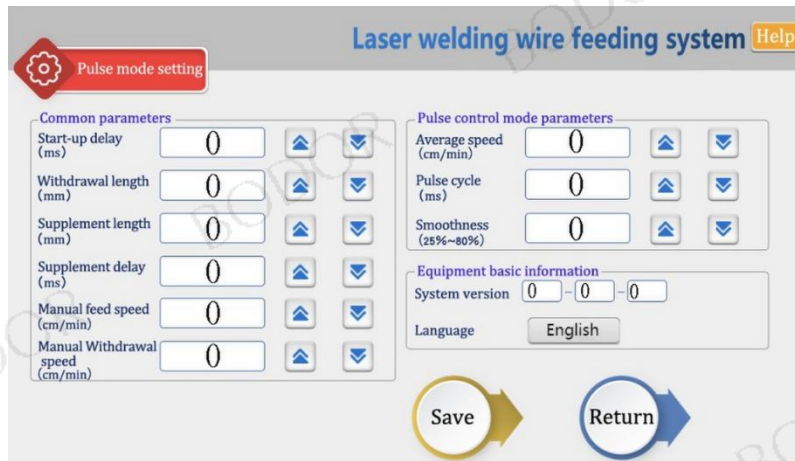

## 6- Startup procedure

### WARNING:

© Make sure all electrical connections are connected before use. If conditions permit, all connectors must be tightened and secured with screws.

© When operating the laser, do not directly look at the output fiber, and wear safety glasses. When connecting cables, turn off all power switches of the laser. The startup process is as follows:

- (1) Connect the power input to the indicated voltage, phase, and frequency;
- (2) The connection is securely locked to the loop interface, the wire feed power cord is connected, and the signal line of the wire FEEDER is connected to the FEEDER;
- (3) Connect the protection GAS pipe (6mm) to the GAS IN interface, and open the gas valve;
- (4) Turn the key and press the reset button once;
- (5) Press the knob screen, enter the software interface, adjust the corresponding parameters (laser power, swing amplitude, swing frequency, blowing off gas delay, power slow up slow down, light mode and other parameters);
- (6) The crocodile clip is clamped on the workpiece that needs to be welded;
- (7) Open the laser start button and laser enable switch;
- (8) Hold the gun head in hand, then press and hold the gun head switch.

## 7- Protective mirror replacement

1. Before operation, please clean and dry your hands first, and then wipe your hands again with cotton dipped in alcohol.

2. Open the cover of the mirror compartment in a clean and dust-free place, pull out the lens holder, do a good job of protection (covered with paper), check the protective lens, if there is an obvious burning point on the surface of the lens, it should be replaced directly.

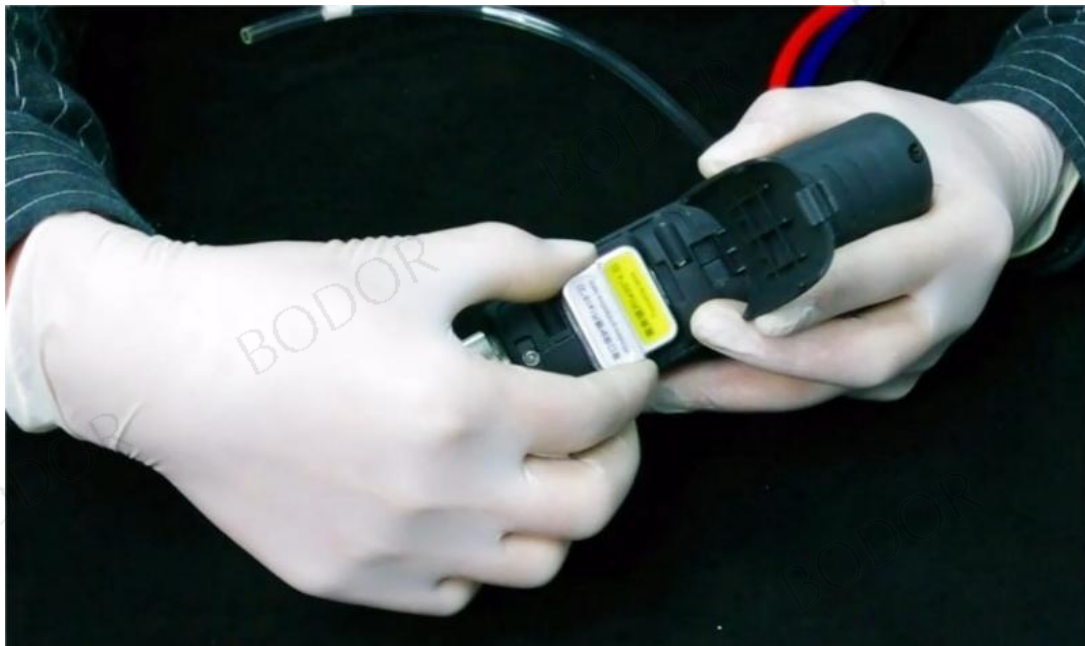

3. Then check the flooding seal below the lens. If there are any scratches or deformations on the plug seal, it cannot be used and must be replaced immediately;

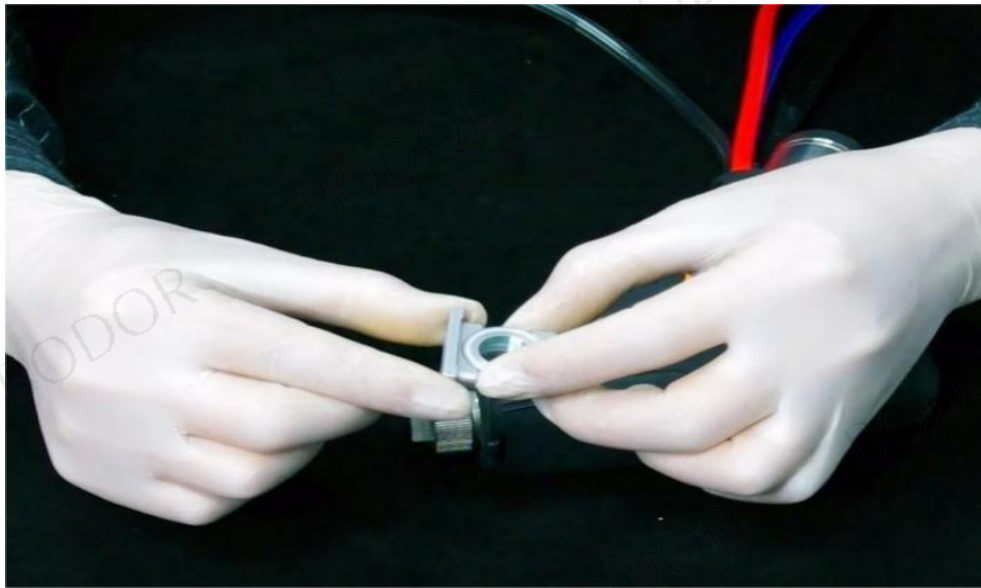

4. When replacing the lens, please first remove the pan plug seal, slowly pour out the burned protective mirror, then use alcohol cotton to carefully wipe the protective mirror bracket and pan plug seal, and use clean compressed air to dry, and finally put the new protective mirror slowly into the trough of the protective mirror bracket to install the pan plug seal.

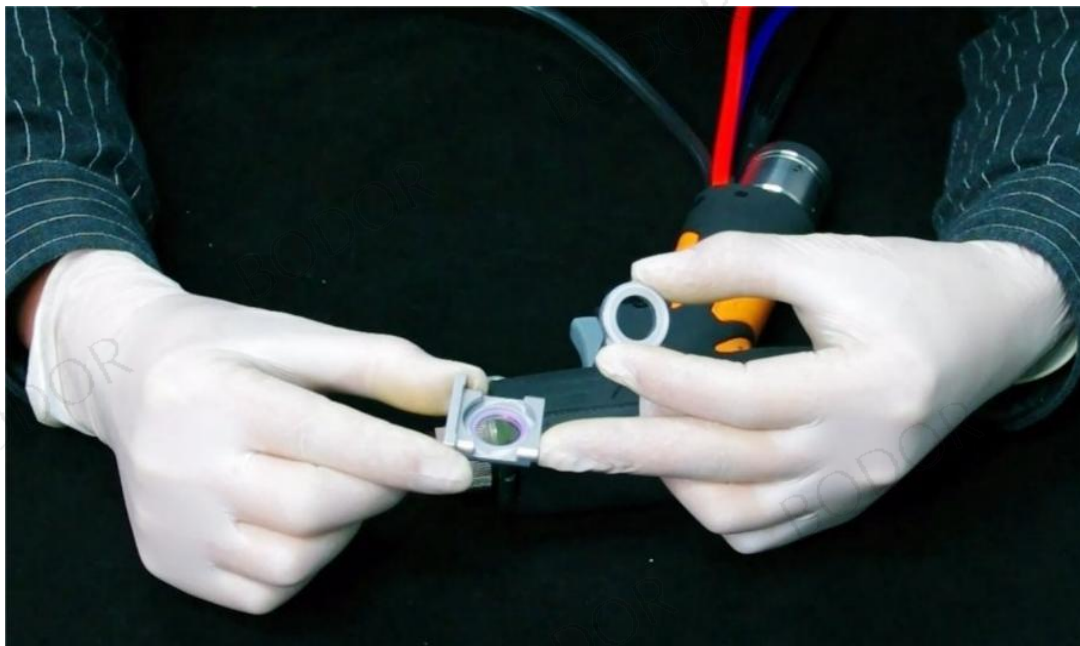



5. Wipe the mouth of the compartment and the inside of the compartment cover with a cotton ball dampened with alcohol, insert the pan seal side of the protective mirror bracket towards the muzzle, and close the compartment cover.

### 8- Welding process parameter

Welding process library										
board	thickness (mm)	TECH	power	Wire feed speed (cm/min)	gas	Air flow (L/Min)	Scan frequency (HZ)	Sweep width (mm)	Wire diameter (mm)	Welding wire material
CS	1	FW	40%	48	N2/Ar	15	50	2.5	1.0	CS
		CW	45%	48	N2/Ar	15	50	2.5	1.0	CS
	2	FW	60%	48	N2/Ar	15	50	2.5	1.0	CS
		CW	65%	48	N2/Ar	15	50	2.5	1.0	CS
	3	FW	80%	48	N2/Ar	15	50	2.5	1.0	CS
		CW	85%	48	N2/Ar	15	50	2.5	1.0	CS
	4	FW	100%	48	N2/Ar	15	50	2.5	1.0	CS
		CW	100%	48	N2/Ar	15	50	2.5	1.0	CS
	5	FW	100%	48	N2/Ar	15	30	2.0	1.0	CS
		CW	100%	48	N2/Ar	15	30	2.0	1.0	CS
SS	1	FW	40%	48	N2	15	50	2.5	1.0	SS

	2	CW	45%	48	N2	15	50	2.5	1.0	SS	
		FW	60%	48	N2	15	50	2.5	1.0	SS	
	3	CW	80%	48	N2	15	50	2.5	1.0	SS	
		FW	85%	48	N2	15	50	2.5	1.0	SS	
	4	CW	85%	48	N2	15	50	2.5	1.0	SS	
		FW	90%	48	N2	15	50	2.5	1.0	SS	
	5	CW	100%	48	N2	15	50	2.5	1.0	SS	
		FW	100%	48	N2	15	30	2.0	1.0	SS	
	AL	1	FW	35%	48	Ar	15	50	2.5	1.0	AL
			CW	40%	48	Ar	15	50	2.5	1.0	AL
2		FW	50%	48	Ar	15	50	2.5	1.0	AL	
		CW	55%	48	Ar	15	50	2.5	1.0	AL	
3		FW	70%	48	Ar	15	50	2.5	1.0	AL	
		CW	75%	48	Ar	15	50	2.5	1.0	AL	
4		FW	100%	48	Ar	15	50	2.5	1.0	AL	
		CW	100%	48	Ar	15	50	2.5	1.0	AL	
CU	1	SW	50%	48	N2/Ar	15	50	2.5	1.0	CU	
		CW	50%	48	N2/Ar	15	50	2.5	1.0	CU	
	2	FW	65%	48	N2/Ar	15	50	2.5	1.0	CU	
		CW	65%	48	N2/Ar	15	50	2.5	1.0	CU	

备注

- 1, the ratio of welding head 50:150, 1500W laser fiber core diameter is 50 μm;
- 2, high carbon steel welding is not recommended to use nitrogen protection;
- 3, power percentage (1500w) 10-100%, swing range 0-4mm (recommended 2-3.5mm), swing frequency 0-220hz (recommended manual welding frequency 40-70hz, gas flow rate is not less than 15l/min), other parameters unchanged, swing range or wire feed speed increase, The laser power also needs to be increased accordingly;
- 4, the wire feeder needs to adjust the wire feed speed, by adjusting the pressure of the wire feed wheel, in the automatic mode, the wire feed speed is uniform, the wire feed is smooth, and there is no stuck phenomenon;
- 5, due to the different equipment configuration (wire feeding machine differences) and welding methods (wire feeding speed, air pressure, degree of deflection, welding Angle) used by different customers, this data is for reference only;
- 6, It is recommended to use graphite wire feed tube for aluminum welding.

## Welding process library

board	thickness (mm)	TECH	power	Wire feed speed (cm/min)	gas	Air flow (L/Min)	Scan frequency (HZ)	Sweep width (mm)	Wire diameter (mm)	Welding wire material
CS	1	SW	30%	75	N2/Ar	15	60	3	1.0	CS
		FW	35%	70	N2/Ar	15	60	3	1.0	CS
	2	SW	55%	70	N2/Ar	15	60	3	1.0	CS
		FW	60%	65	N2/Ar	15	60	3	1.2	CS
	3	SW	75%	65	N2/Ar	15	60	3	1.2	CS
		FW	80%	65	N2/Ar	15	60	3	1.2	CS
	4	SW	100%	60	N2/Ar	15	60	3	1.2	CS
		FW	100%	60	N2/Ar	15	60	3.5	1.2	CS
	5	SW	100%	50	N2/Ar	15	50	3.5	1.2	CS
		FW	100%	50	N2/Ar	15	50	3.5	1.2	CS
SS	1	SW	27%	80	N2	15	60	3	1.0	SS
		FW	30%	70	N2	15	60	3	1.0	SS
	2	SW	38%	80	N2	15	60	3	1.0	SS
		FW	40%	80	N2	15	60	3	1.0	SS
	3	SW	70%	60	N2	15	60	3	1.2	SS
		FW	85%	50	N2	15	60	3	1.2	SS
	4	SW	90%	60	N2	15	60	3	1.2	SS
		FW	100%	45	N2	15	50	3	1.2	SS
	5	SW	100%	50	N2	15	50	3	1.2	SS
		FW	100%	35	N2	15	50	3	1.2	SS
AL	1	SW	37%	75	Ar	15	60	3	1.2	AL
		FW	40%	80	Ar	15	60	3.5	1.2	AL
	2	SW	58%	68	Ar	15	60	3.5	1.2	AL
		FW	70%	68	Ar	15	60	3.5	1.2	AL
	3	SW	90%	60	Ar	15	60	3.5	1.2	AL
		FW	100%	55	Ar	15	60	3.5	1.2	AL
	4	SW	100%	55	Ar	15	60	3.5	1.2	AL
		FW	100%	45	Ar	15	60	3.5	1.2	AL
CU	1	FW	75%	55	N2/Ar	15	110	3.5	1.0	CU
	2	FW	100%	60	N2/Ar	15	100	3.5	1.0	CU

备注

1, the ratio of welding head 50:150, 1500W laser fiber core diameter is 50 μm;  
 2, high carbon steel welding is not recommended to use nitrogen protection;  
 3, power percentage (1500w) 10-100%, swing range 0-4mm (recommended 2-3.5mm), swing frequency 0-220hz (recommended manual welding frequency 40-70hz, gas flow rate is not less than 15l/min), other parameters unchanged, swing range or wire feed speed increase, The laser power also needs to be increased accordingly;  
 4, the wire feeder needs to adjust the wire feed speed, by adjusting the pressure of the wire feed wheel, in the automatic mode, the wire feed speed is uniform, the wire feed is smooth, and there is no stuck phenomenon;



5, due to the different equipment configuration (wire feeding machine differences) and welding methods (wire feeding speed, air pressure, degree of deflection, welding Angle) used by different customers, this data is for reference only;

## 9- Fault list

The alarm points for the laser are as follows:

Serial Number	Alarm Code	Fault Name	Fault Cause	Remark
1	ER-001	Temperature alarm	The laser overtemperature is faulty	The internal temperature fault of the laser, the long-term operation of the laser will also lead to the accumulation temperature is too high, and the light needs to be stopped and cooled before it can be used again.
2	ER-002	Humidity alarm	Excessive internal humidity	The internal humidity of the laser exceeds the threshold. Check whether the ambient humidity is too high
3	ER-003	Forward alarm to PD	The internal optical path of the laser is faulty	The causes of this failure are: low modulation frequency, low peak power, low cutting power, and other operations that may cause low output power of the laser.
4	ER-004	Spatial PD alarm	The internal optical path of the laser is faulty	The possible causes are as follows: The optical fiber is damaged or light leaks
5	ER-005	Overcurrent alarm	The current of the driver board is too large	The laser driver is abnormal. Contact the after-sales service

				for confirmation.
6	ER-006	Scram alarm	The emergency stop button is pressed	The emergency stop button is pressed.
7	ER-007	Air pressure alarm	Welding pressure is too low	The welding air pressure should be >0.3bar, otherwise the air pressure alarm will be triggered.
8	ER-008	Welding torch head PD alarm	Standby	Standby
9	ER-009	Torch head temperature alarm	Lenses are dirty or the ambient temperature is too high	Check the state of the welding torch lens or suspend the operation to cool the welding torch after a long time.

**WARNING:**

© All laser alarm information will have a corresponding display reminder on the monitoring software; Please pay attention! If you have any questions, please contact our customer service.

## Chapter 7 Maintenance

Equipment maintenance must be stopped first, cut off the power supply, 5 minutes before operation, otherwise there will be a risk of electric shock.

Weekly inspection is the main content of daily maintenance of welding machine. Daily maintenance should analyze the running status, vibration, noise, and operating data of the equipment to find out whether there are security risks in advance. It mainly includes the following contents:

Check the filter and clean the dust and foreign matter on it. The specific steps are as follows:

1. Disassemble the six screws on the air inlet plate;
2. Pull the air filter upward and remove it for cleaning;
3. Check whether the condenser has dust and foreign matter, and use compressed air for simple cleaning;
4. Insert the clean air filter into the air intake plate and secure the six screws.



Air inlet panels

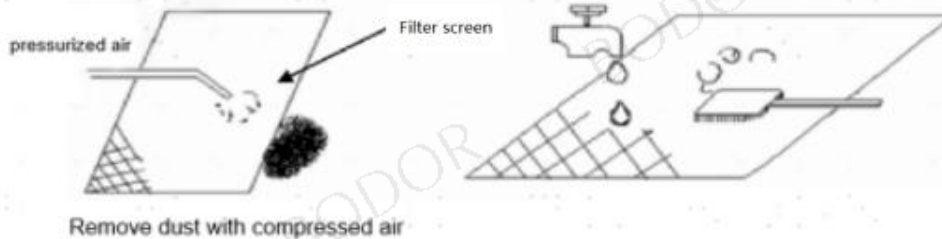

## Chapter 8 Transportation and Storage

### 1- Transport requirement

Do not move the device up and down or tilt it excessively. Pay attention to the anti-tipping label to avoid bumps and collisions.

### 2-Storage requirement

1. Please place the machine away from dust;
2. Please wipe the surface of the body clean, use the air pump to blow the dust inside, wipe away the oil;
3. Cover the outside of the device with a protective cover to prevent dust and water attachment;
4. Store the machine on flat ground, dry and ventilated place, avoid direct sunlight;
5. If the equipment is equipped with casters, please ensure that the casters are

fixed or locked to avoid injury caused by sliding casters;

Change Human Life with Laser Technology

Jinan Shandong China  
Tel: +86-531-88690051  
Company website: [www.bodor.com](http://www.bodor.com)  
Jinan Bodor CNC Machine Co., Ltd.

